



# GENERAL WARNINGS AND CAUTIONARY STATEMENTS FOR REMOVABLE BOLLARDS

In order to safely and effectively use any TrafficGuard<sup>®</sup>, Inc. product, please read and understand the General Warnings and Cautionary Statements contained below. If you have any questions about any of these General Warnings and Cautionary Statements, or about any aspect of TrafficGuard<sup>®</sup>, Inc.'s products or literature, please contact TrafficGuard<sup>®</sup>, Inc. at 877-727-7347, or email [sales@trafficguard.net](mailto:sales@trafficguard.net).



## **BOLLARD SELECTION AND PLACEMENT**

based on vehicle weight, speed and other site specific factors to be determined by owner.



## **FAILURE TO UTILIZE TRAFFICGUARD<sup>®</sup>, INC. AUTHORIZED PARTS, OR MODIFICATIONS**

to the TrafficGuard<sup>®</sup>, Inc. products, or failure to follow the recommended installation procedures, will result in your warranty being null and void.



## **READ AND FULLY UNDERSTAND THE INSTALLATION INSTRUCTIONS**

before attempting to install any TrafficGuard<sup>®</sup>, Inc. bollard product.



## **SUBSTITUTION OF COMPONENTS MAY IMPAIR THE PROPER FUNCTION**

of TrafficGuard<sup>®</sup>, Inc. bollards products. If you need replacement parts, please contact TrafficGuard<sup>®</sup>, Inc. at the number and email above.



**WARNING: FAILURE TO FILL/COVER AN OPEN GROUND SLEEVE ON ALL REMOVABLE BOLLARDS MAY RESULT IS DAMAGE TO VEHICLES OR INJURY TO PEDESTRIANS. ALWAYS FILL/COVER THE GROUND SLEEVE PER TRAFFICGUARD<sup>®</sup>, INC. INSTRUCTIONS.**



## **REPLACEMENT GROUND SLEEVE FILLER PIECES ARE AVAILABLE**

for purchase at TrafficGuard<sup>®</sup>, Inc. For purchase of replacement ground sleeve filler pieces or other components, please contact TrafficGuard<sup>®</sup>, Inc. at the number or email above.



**CAUTION: BOLLARD MUST ALWAYS BE SECURED WITH LOCK MECHANISM WHEN BOLLARD IS IN THE GROUND SLEEVE TO AVOID MISUSE.**



## **FOR MAXIMUM EFFECTIVENESS**

of TrafficGuard<sup>®</sup>, Inc. bollard products, be sure to properly maintain bollards by replacing any damaged, corroded or missing components, and reapply paint as required to maximize visibility. Failure to properly maintain product can negatively impact the bollards performance over time.



## **TO ENSURE VISIBILITY**

of bollards, be sure to apply all decals that are provided with the product, and in the manner recommended by TrafficGuard<sup>®</sup>, Inc.

**IF IN DOUBT CALL TRAFFICGUARD<sup>®</sup>, INC. 877-727-7347**



# INSTALLATION DETAILS

## FOR RP3500 SERIES KEY LOCK REMOVABLE BOLLARDS

- 1 NEVER ATTEMPT TO PLACE THE BOLLARD INTO THE GROUND SLEEVE WHILE IN THE LOCKED POSITION.**
- 2 PAY CAREFUL ATTENTION** to the placement of the location of the ground sleeve latch pin – this determines the location of the lock at the top of the post.
- 3 INSTALLATION OF A SMALLER FOUNDATION** than that specified may reduce the overall impact capacity of the TrafficGuard, Inc. Bollard System.
- 4 TO PROTECT AGAINST A TRIP HAZARD** insert the galvanized ground sleeve filler piece at all times the bollard is removed from the ground sleeve insert.
- 5 PROPER DRAINAGE IS CRITICAL** to the life of the bollard and the locking system. You must keep water from standing in the hole.

**IF YOU HAVE ANY CONCERNS OR QUESTIONS** before beginning the installation please call **TRAFFICGUARD, Inc. 877-727-7347 TOLL FREE.**

## ROUND POST KEY LOCK BOLLARD SERIES

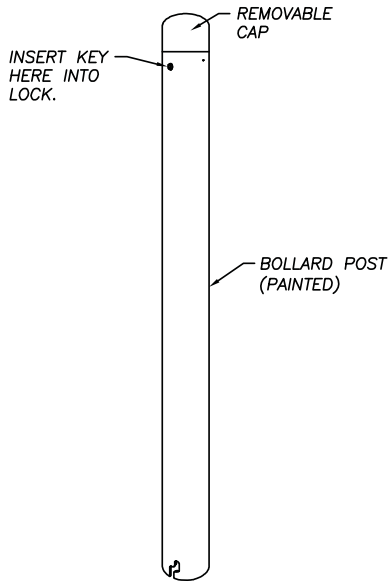

**3" DIA. BOLLARD**

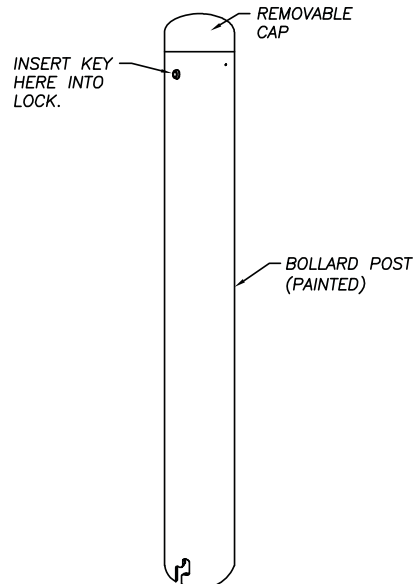

**4.5" DIA. BOLLARD**

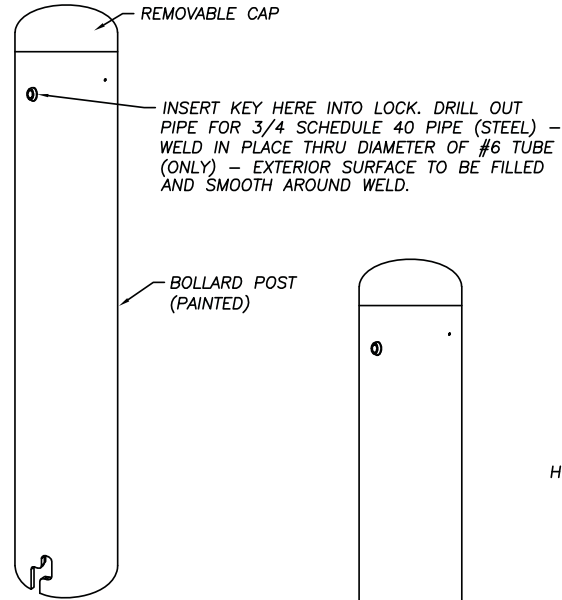

**6.625" DIA. BOLLARD**

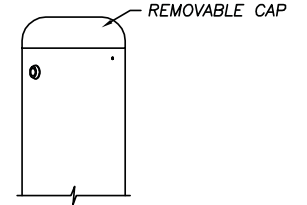

**REMOVABLE CAP SIDE VIEW**

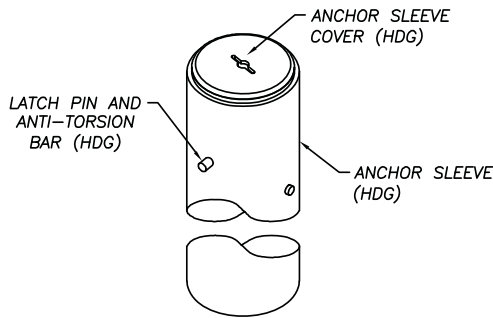

**REMOVED POSITION**

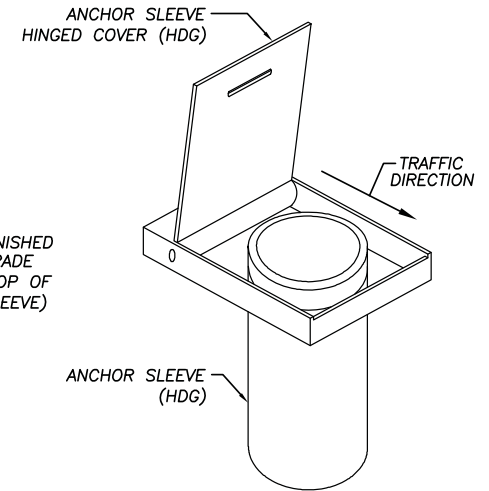
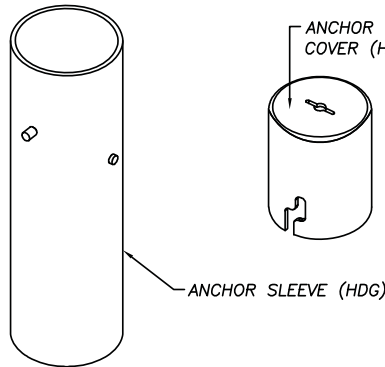

**ALTERNATE ANCHOR SLEEVE, LIDDED GROUND SLEEVE**

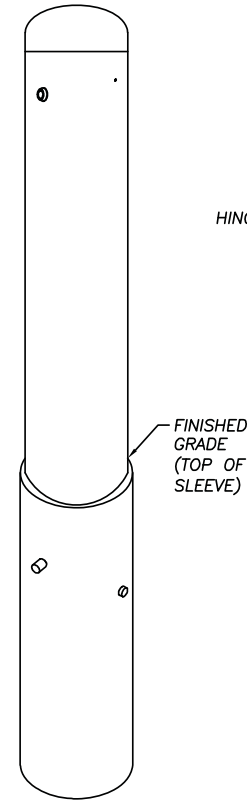

**INSTALLED POSITION**

**TrafficGuard® Inc.**  
 "Authorities on Limiting Access"  
 P.O. Box 201, Geneva, IL. 60134  
 877-727-7347  
 www.trafficguard.net

ATTACH REFLECTIVE WARNING LABELS PROVIDED TO THE FRONT & BACK OF BOLLARD AFTER INSTALLATION.

<b>TrafficGuard® Inc.</b> www.trafficguard.net P.O. Box 201, Geneva, IL. 60134 Bus: 877-727-7347 Fax: 800-814-7194		NAME: <b>DISPLAY</b>	USED IN:	TOLERANCES: DX = ± 0.1 DXX = ± 0.06 ANGULAR = ± 1° FRACTION = 1/16	ACTION: DESIGN: WKZ DRAWING: CJD CHECKED: WKZ	BY: WKZ SCALE: 1:4 DATE: 10-10-14 WT: 135 LBS COPYRIGHT: 2006	DRAWING NUMBER: RP 3504 and RP 3506 SIZE: 34 X 22 SHEET: 1 of 1
---	--	----------------------	----------	--	--	---	--

# CONSTRUCTION DATA SCHEDULE RPAS

1. THE DESIGN LOAD IS A STATIC LOAD "P" APPLIED AT 27 INCHES ABOVE GRADE.
2. THE EARTH PRESSURE VALUE IS SHOWN AT DESIGN LOAD AND THE OWNER SHOULD VERIFY THAT THE EARTH IS ADEQUATE TO WITHSTAND THE NOTED EARTH DESIGN PRESSURE.
3. ANCHORAGE SYSTEMS BY OTHERS THAN TRAFFICGUARD,<sup>®</sup> INC. MAY CAUSE PREMATURE FAILURE OF THE BOLLARD.

NOTE: CONCRETE, FORM, ROCK, PVC DRAIN AND REBAR PROVIDED BY OTHERS										
DESIGN LOAD P	BOLLARD		EARTH "Q" MAX.	PIER HT. "C" MIN.	VERT. REBAR		HOOP TIES	PIER CONCRETE	FRENCH DRAIN	PIER "D"
	Out Dia.	Ins Dia.			LENGTH	QTY				
600 #	1.910"	1.620"	992 PSF	42 INCH	38 INCH	3	6 EA.	6 Cu Ft	1.2 CF	8"
1200 #	2.440"	2.064"	1984 PSF	42 INCH	38 INCH	3	6 EA.	6 Cu Ft	1.2 CF	8"
3000 #	3.500"	3.068"	2204 PSF	42 INCH	38 INCH	4	6 EA.	6 Cu Ft	0.5 CF	18"
6000 #	4.500"	4.026"	4408 PSF	42 INCH	38 INCH	4	6 EA.	6 Cu Ft	0.5 CF	18"
6000 #	4.500"	4.026"	2667 PSF	54 INCH	50 INCH	4	7 EA.	8 Cu Ft	0.5 CF	18"
10000#	5.563"	5.047"	4444 PSF	54 INCH	50 INCH	4	7 EA.	8 Cu Ft	0.5 CF	18"
10000#	5.563"	5.047"	3600 PSF	60 INCH	56 INCH	4	8 EA.	9 Cu Ft	0.5 CF	18"
10000#	5.563"	5.047"	2975 PSF	66 INCH	62 INCH	4	8 EA.	10 Cu Ft	0.5 CF	18"
15000#	6.625"	6.065"	3750 PSF	72 INCH	68 INCH	4	9 EA.	11 Cu Ft	0.5 CF	18"
15000#	6.625"	6.065"	3195 PSF	78 INCH	72 INCH	4	9 EA.	12 Cu Ft	0.5 CF	18"
15000#	6.625"	6.065"	3240 PSF	60 INCH	56 INCH	8	8 EA.	25 Cu Ft	1.6 CF	30"
15000#	6.625"	6.065"	3333 PSF	54 INCH	50 INCH	8	7 EA.	32 Cu Ft	1.8 CF	36"

THIS IS A GUIDELINE FOR ESTIMATING, SITE SPECIFIC CONDITIONS SHOULD BE VERIFIED.  
 This Drawing shall not be used nor reproduced except when authorized in writing by TrafficGuard,<sup>®</sup> Inc.

## ROUND POST BOLLARD RPAS ANCHORAGE SYSTEM DETAILS

THIRD ANGLE PROJECTION   
 Do not scale from drawing

Toll Free **TrafficGuard,<sup>®</sup> Inc.**  
 P.O. Box 201, Geneva, IL. 60134  
 Bus: 1.877.727.7347 Fax: 1.800.814.7194

3	-	-	-		Action	by				
2	-	-	-		Design	wkz	Dwg. Scale: nts	Assembly Shipping Weight	Drawing Number:	
1	-	-	-		Drawn	wkz	Copywrite: 2010	Varies per Model	RPAS-2	
Rev.	Date	by	Description		Checked	wkz	Dwg. Size: Letter	Drawing Date: 12.10.10	Sheet: 2 of 2	

# PIER ELEVATION SECTION

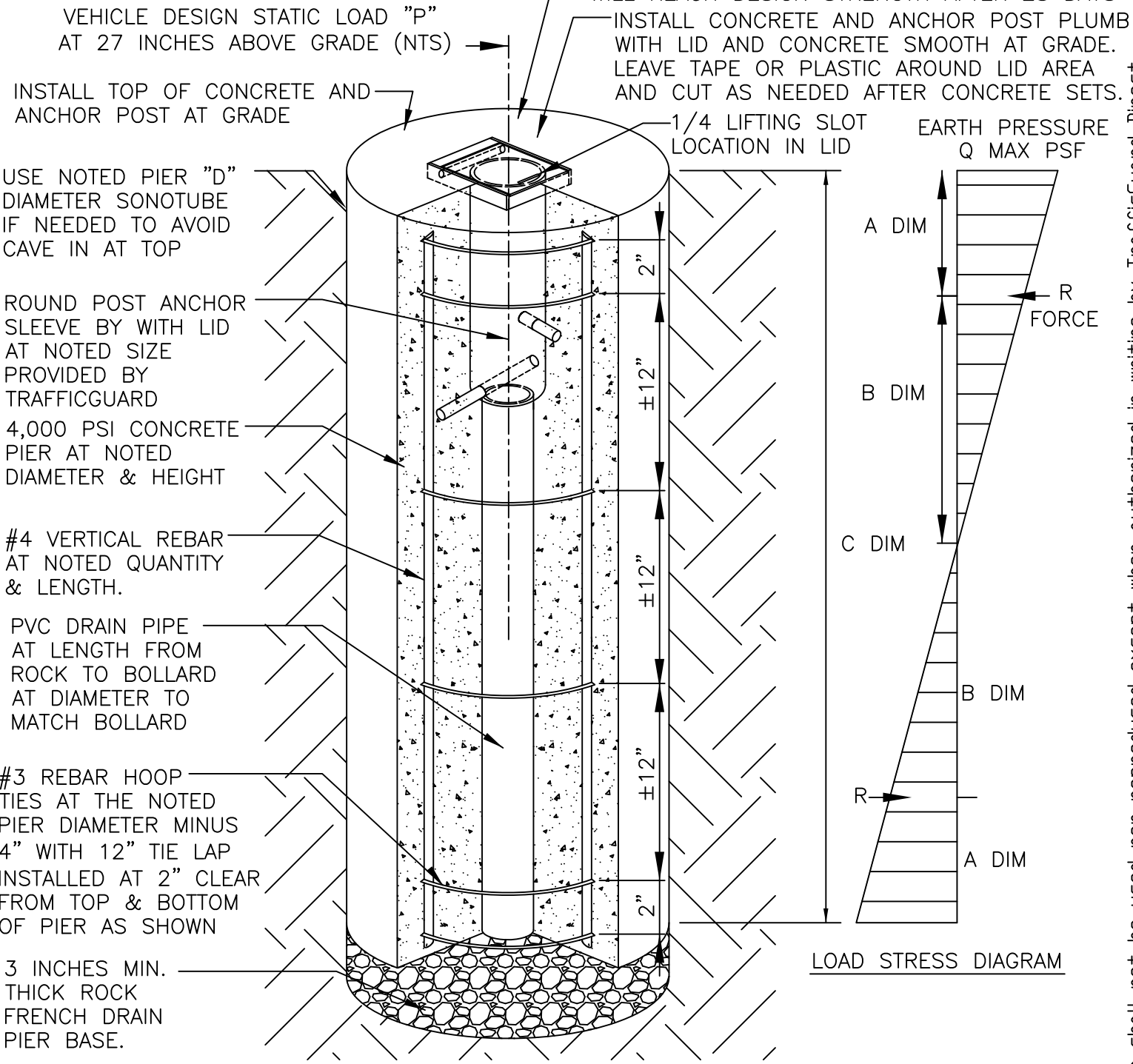

This Drawing shall not be used nor reproduced except when authorized in writing by TrafficGuard Direct.

HOOP REBAR #3	PROVIDED BY OWNER		
VERTICAL REBAR #4	PROVIDED BY OWNER	CONCRETE AND ROCK	PROVIDED BY OWNER
SONOTUBE FORM TUBE	PROVIDED BY OWNER	DRAIN PVC PIPE	PROVIDED BY OWNER
DESCRIPTION	REMARKS	DESCRIPTION	REMARKS

**NOTE** REFER TO RPAS-2 FOR THE ANCHORAGE SYSTEM DIMENSIONS, DESIGN LOADS, REBAR SIZE, QUANTITIES, AND OTHER DESIGN DATA.

LID ROUND POST BOLLARD LRPAS ANCHORAGE SYSTEM ASSEMBLY		THIRD ANGLE PROJECTION	Toll Free		TrafficGuard®	
Do not scale from drawing			P.O. Box 201, Geneva, IL. 60134		Bus: 1.877.727.7347 Fax: 1.800.814.7194	
3	-	-	-	Action	by	
2	-	-	-	Design	wkz	Dwg. Scale: nts
1	-	-	-	Drawn	wkz	Copywrite: 2010
Rev.	Date	by	Description	Checked	wkz	Dwg. Size: Letter
				Drawing Date: 12.10.10		Drawing Number: LRPAS1
				Sheet: 1 of 2		